

Varenummer: 2310431047S
Beskrivelse: E+G Stilleben
LX.40-SW17-M12X52-S

Mål

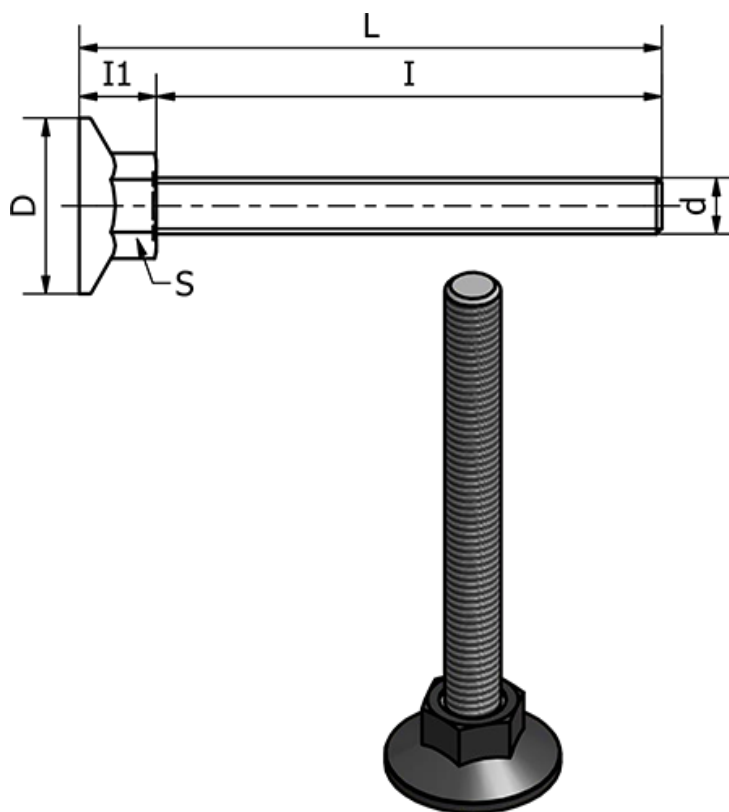

d	= M12
D	= 40
I	= 52
I1	= 13
L	= 64.5
Max statisk belastning (N)	= 5000
S	= 17
Type	= Forzinket

Vægt (g) = -